

## Tiny 1.5A, High-Speed Power MOSFET Driver

### Features

- High Peak Output Current: 1.5A (typical)
- Wide Input Supply Voltage Operating Range:
  - 4.5V to 18V
- Low Shoot-Through/Cross-Conduction Current in Output Stage
- High Capacitive Load Drive Capability:
  - 470 pF in 13 ns (typical)
  - 1000 pF in 18 ns (typical)
- Short Delay Times: 44 ns ( $t_{D1}$ ), 47 ns (MCP1415  $t_{D2}$ ), 54 ns (MCP1416  $t_{D2}$ ) (typical)
- Low Supply Current:
  - With Logic '1' Input - 0.65 mA (typical)
  - With Logic '0' Input - 0.1 mA (typical)
- Latch-Up Protected: Withstands 500 mA Reverse Current
- Logic Input Withstands Negative Swing up to 5V
- Space-Saving 5L SOT-23 Package

### Applications

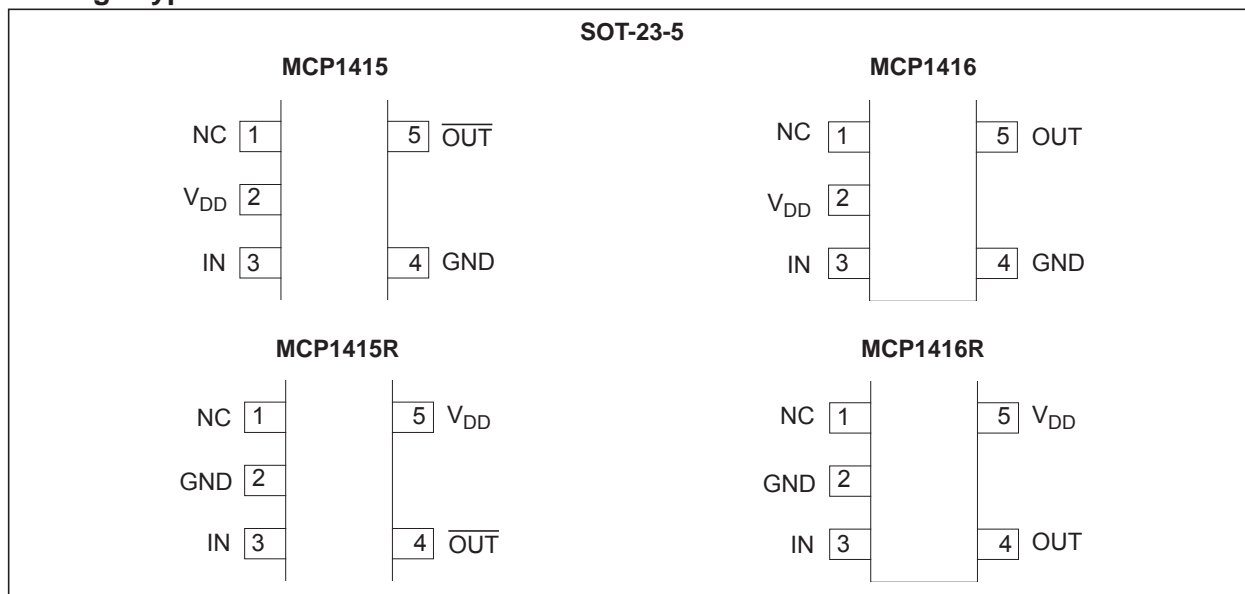
- Switch Mode Power Supplies
- Pulse Transformer Drive
- Line Drivers
- Level Translator
- Motor and Solenoid Drive

### General Description

The MCP1415/16 devices are high-speed, dual MOSFET drivers that are capable of providing up to 1.5A of peak current while operating from a single 4.5V to 18V supply. The inverting or non-inverting single channel output is directly controlled from either TTL or CMOS (3V to 18V) logic. These devices also feature low shoot-through current, matched rise and fall time, and short propagation delays which make them ideal for high switching frequency applications. They provide low enough impedances in both the 'On' and 'Off' states to ensure the intended state of the MOSFET is not affected, even by large transients.

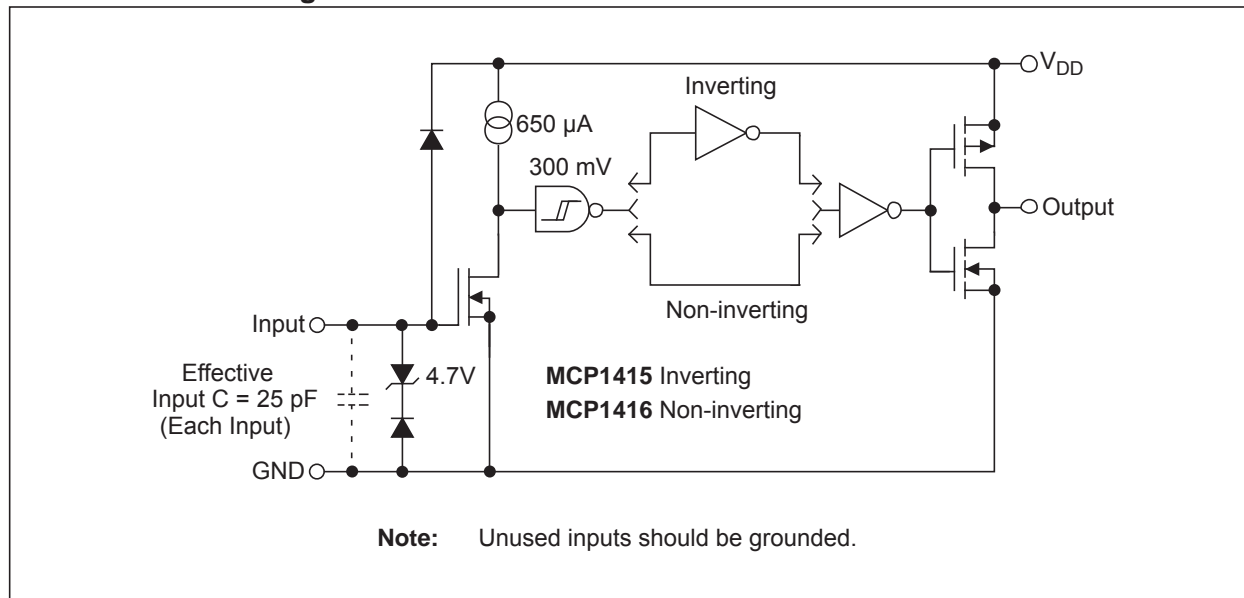
These devices are highly latch-up resistant under any condition within their power and voltage ratings. They are not subject to damage when noise spiking (up to 5V, of either polarity) occurs on the Ground pin. They can accept up to 500 mA of reverse current being forced back into their outputs without damage or logic upset. All terminals are fully protected against electrostatic discharge (ESD) up to 2.0 kV (HBM) and 300V (MM).

### Package Types



# MCP1415/16

## Functional Block Diagram



## 1.0 ELECTRICAL CHARACTERISTICS

### Absolute Maximum Ratings †

|  |                                   |
|--|-----------------------------------|
| $V_{DD}$ , Supply Voltage.....                   | +20V                              |
| $V_{IN}$ , Input Voltage.....                    | ( $V_{DD} + 0.3V$ ) to (GND - 5V) |
| Package Power Dissipation ( $T_A = 50^\circ C$ ) |                                   |
| 5L SOT23.....                                    | 0.39W                             |
| ESD Protection on all Pins.....                  | 2.0 kV (HBM)                      |
| .....  | 300V (MM)                         |

† **Notice:** Stresses above those listed under “Maximum Ratings” may cause permanent damage to the device. This is a stress rating only and functional operation of the device at those or any other conditions above those indicated in the operational sections of this specification is not intended. Exposure to maximum rating conditions for extended periods may affect device reliability.

### DC CHARACTERISTICS

| Electrical Specifications: Unless otherwise noted, $T_A = +25^\circ C$ , with $4.5V \leq V_{DD} \leq 18V$ |           |                  |      |                |          |   |
|---|-----------|------------------|------|----------------|----------|---|
| Parameters  | Sym.      | Min.             | Typ. | Max.           | Units    | Conditions  |
| <b>Input</b>  |           |                  |      |                |          |   |
| Logic '1' High Input Voltage  | $V_{IH}$  | 2.4              | 1.9  | —              | V        |   |
| Logic '0' Low Input Voltage   | $V_{IL}$  | —                | 1.6  | 0.8            | V        |   |
| Input Current   | $I_{IN}$  | -1               | —    | +1             | $\mu A$  | $0V \leq V_{IN} \leq V_{DD}$  |
| Input Voltage   | $V_{IN}$  | -5               | —    | $V_{DD} + 0.3$ | V        |   |
| <b>Output</b>   |           |                  |      |                |          |   |
| High Output Voltage   | $V_{OH}$  | $V_{DD} - 0.025$ | —    | —              | V        | DC Test   |
| Low Output Voltage  | $V_{OL}$  | —                | —    | 0.025          | V        | DC Test   |
| Output Resistance, High   | $R_{OH}$  | —                | 6    | 7.5            | $\Omega$ | $I_{OUT} = 10\text{ mA}$ , $V_{DD} = 18V$<br><b>(Note 1)</b>                      |
| Output Resistance, Low  | $R_{OL}$  | —                | 4    | 5.5            | $\Omega$ | $I_{OUT} = 10\text{ mA}$ , $V_{DD} = 18V$<br><b>(Note 1)</b>                      |
| Peak Output Current   | $I_{PK}$  | —                | 1.5  | —              | A        | $V_{DD} = 18V$ <b>(Note 1)</b>  |
| Latch-Up Protection Withstand Reverse Current   | $I_{REV}$ | 0.5              | —    | —              | A        | Duty cycle $\leq 2\%$ , $t \leq 300\ \mu s$<br><b>(Note 1)</b>                    |
| <b>Switching Time (Note 1)</b>  |           |                  |      |                |          |   |
| Rise Time   | $t_R$     | —                | 18   | 25             | ns       | $V_{DD} = 18V$ , $C_L = 1000\text{ pF}$<br>Figure 4-1, Figure 4-2 <b>(Note 1)</b> |
| Fall Time   | $t_F$     | —                | 21   | 28             | ns       | $V_{DD} = 18V$ , $C_L = 1000\text{ pF}$<br>Figure 4-1, Figure 4-2 <b>(Note 1)</b> |
| Delay Time  | $t_{D1}$  | —                | 44   | 54             | ns       | $V_{DD} = 18V$ , $V_{IN} = 5V$<br>Figure 4-1, Figure 4-2 <b>(Note 1)</b>          |
| MCP1415 Delay Time  | $t_{D2}$  | —                | 47   | 57             | ns       | $V_{DD} = 18V$ , $V_{IN} = 5V$<br>Figure 4-1 <b>(Note 1)</b>                      |
| MCP1416 Delay Time  | $t_{D2}$  | —                | 54   | 64             | ns       | $V_{DD} = 18V$ , $V_{IN} = 5V$<br>Figure 4-2 <b>(Note 1)</b>                      |
| <b>Power Supply</b>   |           |                  |      |                |          |   |
| Supply Voltage  | $V_{DD}$  | 4.5              | —    | 18             | V        |   |
| Power Supply Current  | $I_S$     | —                | 0.65 | 1.1            | mA       | $V_{IN} = 3V$   |
|   | $I_S$     | —                | 0.1  | 0.15           | mA       | $V_{IN} = 0V$   |

**Note 1:** Tested during characterization, not production tested.

# MCP1415/16

## DC CHARACTERISTICS (OVER OPERATING TEMPERATURE RANGE) (Note 1)

| Electrical Specifications: Unless otherwise indicated, over the operating range with $4.5V \leq V_{DD} \leq 18V$ . |          |                  |      |                |          |  |
|--|----------|------------------|------|----------------|----------|--|
| Parameters   | Sym.     | Min.             | Typ. | Max.           | Units    | Conditions   |
| <b>Input</b>   |          |                  |      |                |          |  |
| Logic '1', High Input Voltage  | $V_{IH}$ | 2.4              | —    | —              | V        |  |
| Logic '0', Low Input Voltage   | $V_{IL}$ | —                | —    | 0.8            | V        |  |
| Input Current  | $I_{IN}$ | -10              | —    | +10            | $\mu A$  | $0V \leq V_{IN} \leq V_{DD}$                                       |
| Input Voltage  | $V_{IN}$ | -5               | —    | $V_{DD} + 0.3$ | V        |  |
| <b>Output</b>  |          |                  |      |                |          |  |
| High Output Voltage  | $V_{OH}$ | $V_{DD} - 0.025$ | —    | —              | V        | DC Test  |
| Low Output Voltage   | $V_{OL}$ | —                | —    | 0.025          | V        | DC Test  |
| Output Resistance, High  | $R_{OH}$ | —                | 8.5  | 9.5            | $\Omega$ | $I_{OUT} = 10 \text{ mA}$ , $V_{DD} = 18V$                         |
| Output Resistance, Low   | $R_{OL}$ | —                | 6    | 7              | $\Omega$ | $I_{OUT} = 10 \text{ mA}$ , $V_{DD} = 18V$                         |
| <b>Switching Time</b>  |          |                  |      |                |          |  |
| Rise Time  | $t_R$    | —                | 26   | 37             | ns       | $V_{DD} = 18V$ , $C_L = 1000 \text{ pF}$<br>Figure 4-1, Figure 4-2 |
| Fall Time  | $t_F$    | —                | 29   | 40             | ns       | $V_{DD} = 18V$ , $C_L = 1000 \text{ pF}$<br>Figure 4-1, Figure 4-2 |
| Delay Time   | $t_{D1}$ | —                | 60   | 70             | ns       | $V_{DD} = 18V$ , $V_{IN} = 5V$<br>Figure 4-1, Figure 4-2           |
| MCP1415 Delay Time   | $t_{D2}$ | —                | 62   | 72             | ns       | $V_{DD} = 18V$ , $V_{IN} = 5V$<br>Figure 4-1                       |
| MCP1416 Delay Time   | $t_{D2}$ | —                | 72   | 82             | ns       | $V_{DD} = 18V$ , $V_{IN} = 5V$<br>Figure 4-2                       |
| <b>Power Supply</b>  |          |                  |      |                |          |  |
| Supply Voltage   | $V_{DD}$ | 4.5              | —    | 18             | V        |  |
| Power Supply Current   | $I_S$    | —                | 0.75 | 1.5            | mA       | $V_{IN} = 3.0V$  |
|  | $I_S$    | —                | 0.15 | 0.25           | mA       | $V_{IN} = 0V$  |

**Note 1:** Tested during characterization, not production tested.

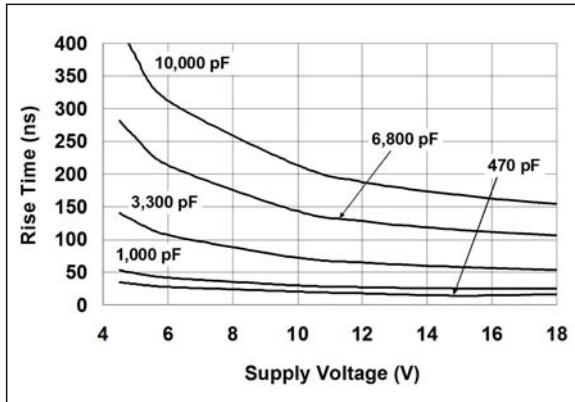
## TEMPERATURE CHARACTERISTICS

| Electrical Specifications: Unless otherwise noted, all parameters apply with $4.5V \leq V_{DD} \leq 18V$ |               |      |       |      |               |          |
|--|---------------|------|-------|------|---------------|----------|
| Parameter  | Sym.          | Min. | Typ.  | Max. | Units         | Comments |
| <b>Temperature Ranges</b>  |               |      |       |      |               |          |
| Specified Temperature Range  | $T_A$         | -40  | —     | +125 | $^{\circ}C$   |          |
| Maximum Junction Temperature   | $T_J$         | —    | —     | +150 | $^{\circ}C$   |          |
| Storage Temperature Range  | $T_A$         | -65  | —     | +150 | $^{\circ}C$   |          |
| <b>Package Thermal Resistances</b>   |               |      |       |      |               |          |
| Thermal Resistance, 5LD SOT23  | $\theta_{JA}$ | —    | 220.7 | —    | $^{\circ}C/W$ |          |

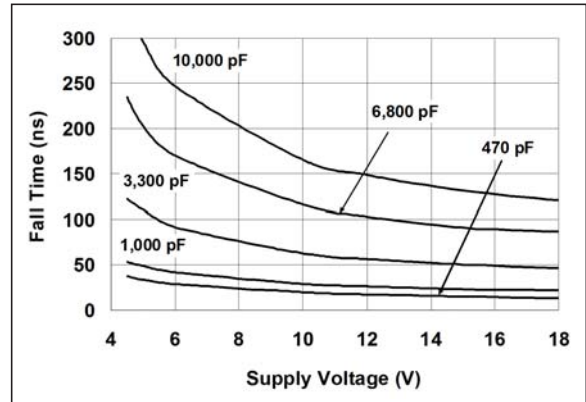
## 2.0 TYPICAL PERFORMANCE CURVES

**Note:** The graphs and tables provided following this note are a statistical summary based on a limited number of samples and are provided for informational purposes only. The performance characteristics listed herein are not tested or guaranteed. In some graphs or tables, the data presented may be outside the specified operating range (e.g., outside specified power supply range) and therefore outside the warranted range.

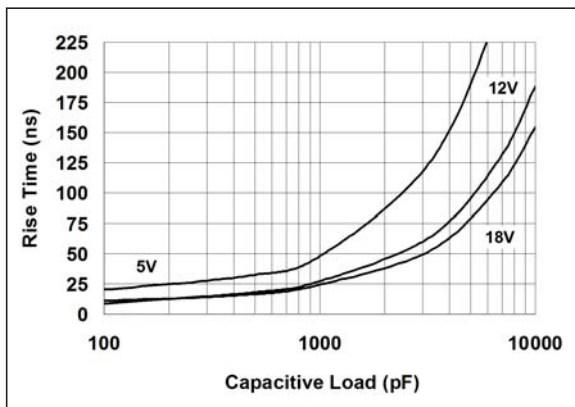
**Note:** Unless otherwise indicated,  $T_A = +25^\circ\text{C}$  with  $4.5\text{V} \leq V_{DD} \leq 18\text{V}$ .



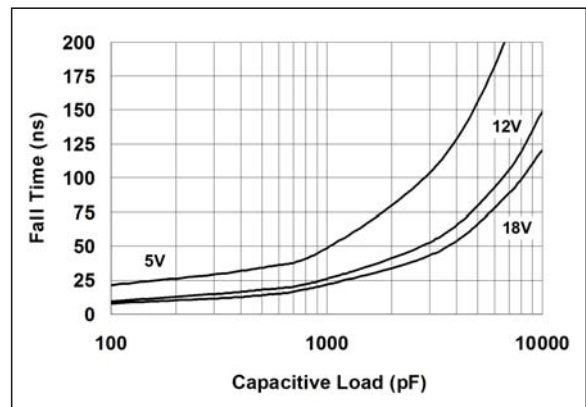
**FIGURE 2-1:** Rise Time vs. Supply Voltage.



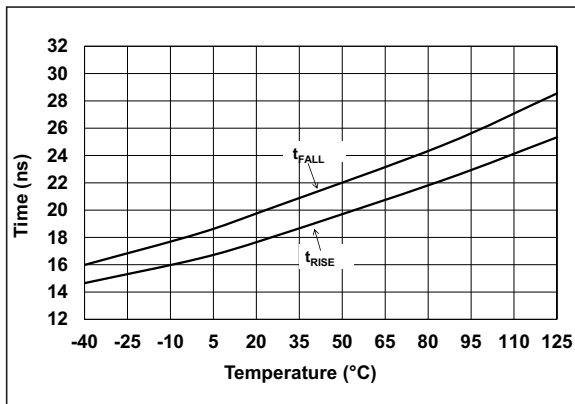
**FIGURE 2-4:** Fall Time vs. Supply Voltage.



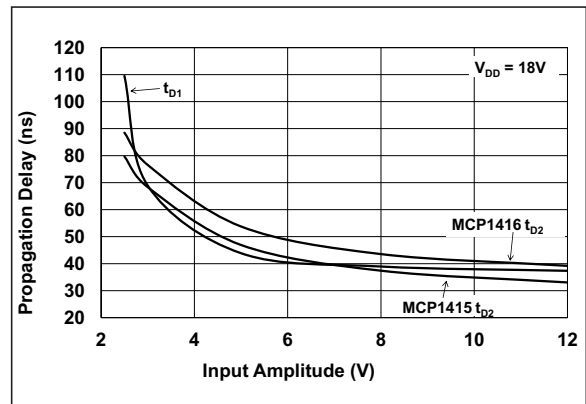
**FIGURE 2-2:** Rise Time vs. Capacitive Load.



**FIGURE 2-5:** Fall Time vs. Capacitive Load.



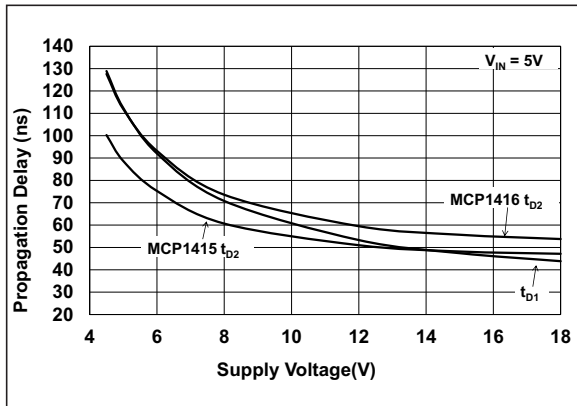
**FIGURE 2-3:** Rise and Fall Times vs. Temperature.



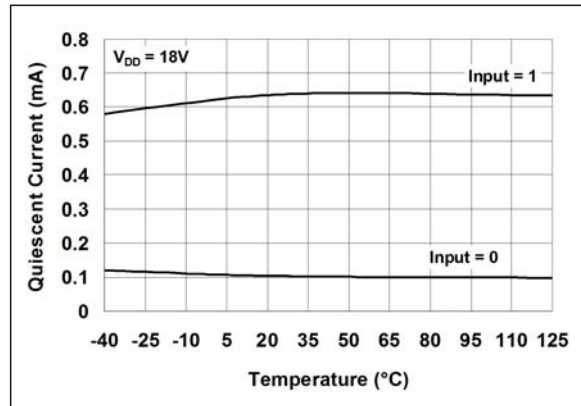
**FIGURE 2-6:** Propagation Delay Time vs. Input Amplitude.

# MCP1415/16

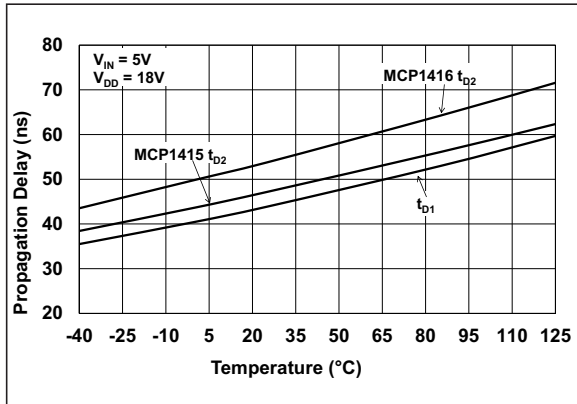
Note: Unless otherwise indicated,  $T_A = +25^\circ\text{C}$  with  $4.5\text{V} \leq V_{DD} \leq 18\text{V}$ .



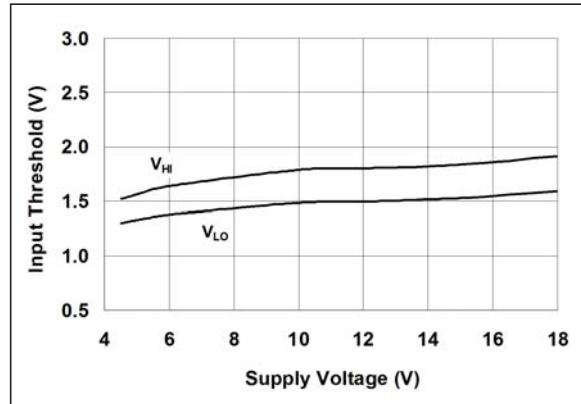
**FIGURE 2-7:** Propagation Delay Time vs. Supply Voltage.



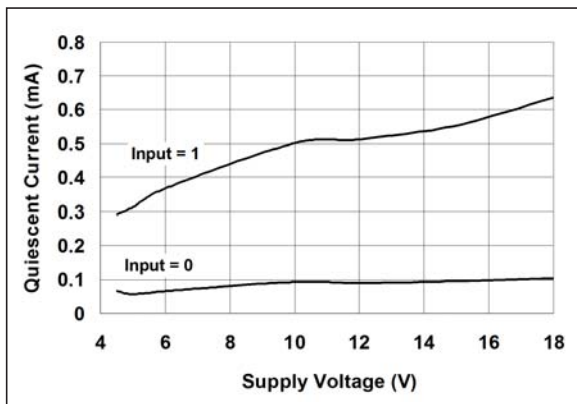
**FIGURE 2-10:** Quiescent Current vs. Temperature.



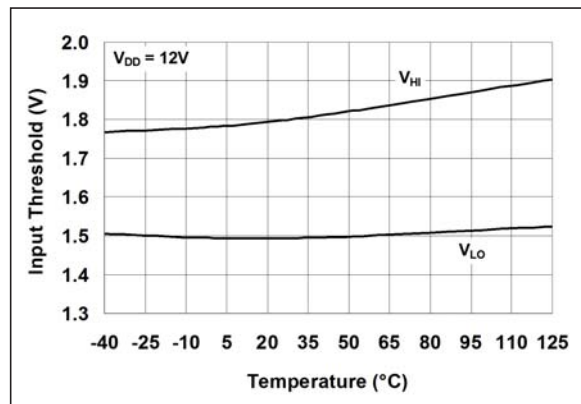
**FIGURE 2-8:** Propagation Delay Time vs. Temperature.



**FIGURE 2-11:** Input Threshold vs. Supply Voltage.

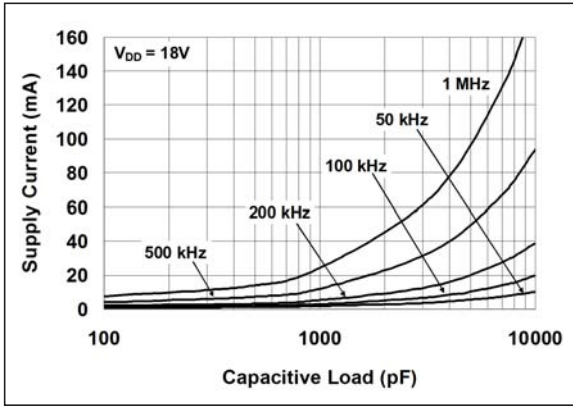


**FIGURE 2-9:** Quiescent Current vs. Supply Voltage.

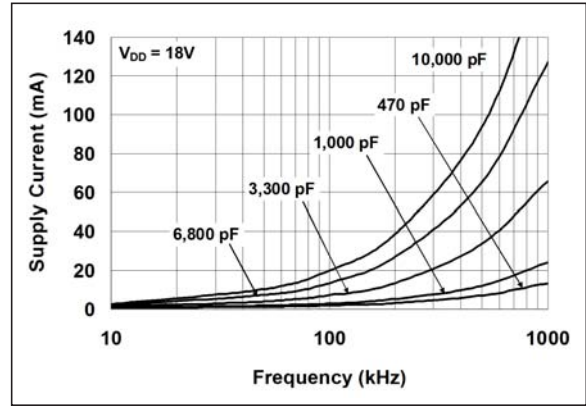


**FIGURE 2-12:** Input Threshold vs. Temperature.

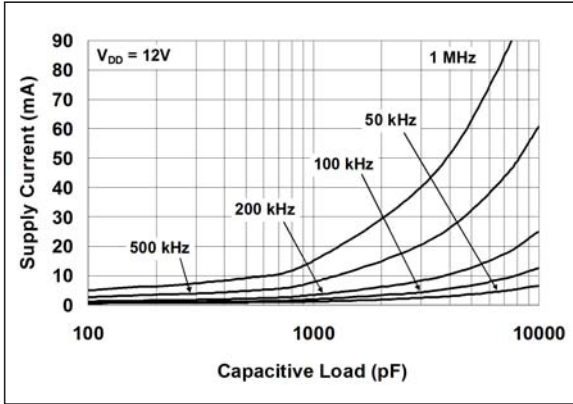
**Note:** Unless otherwise indicated,  $T_A = +25^\circ\text{C}$  with  $4.5\text{V} \leq V_{DD} \leq 18\text{V}$ .



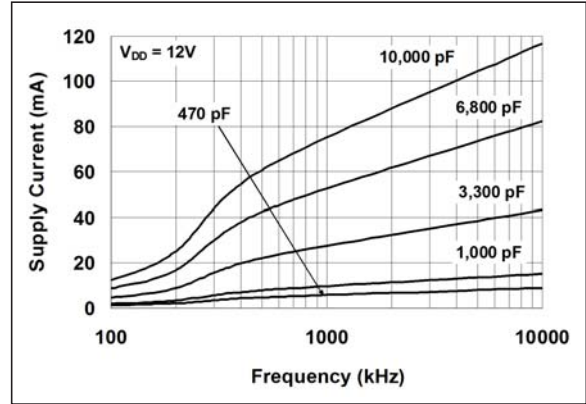
**FIGURE 2-13:** Supply Current vs. Capacitive Load.



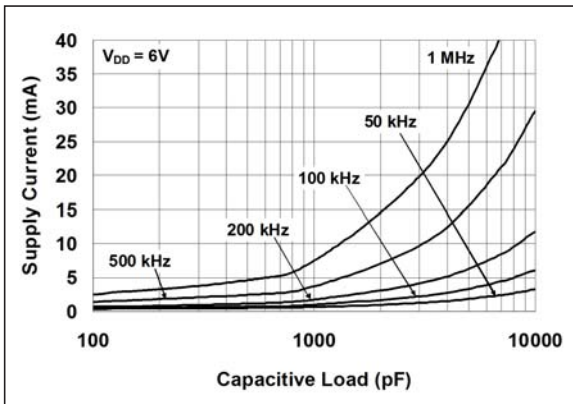
**FIGURE 2-16:** Supply Current vs. Frequency.



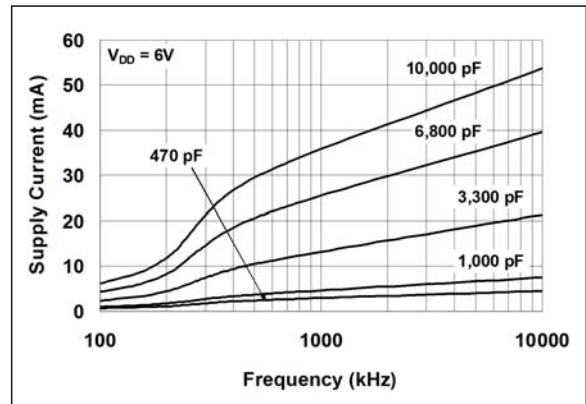
**FIGURE 2-14:** Supply Current vs. Capacitive Load.



**FIGURE 2-17:** Supply Current vs. Frequency.



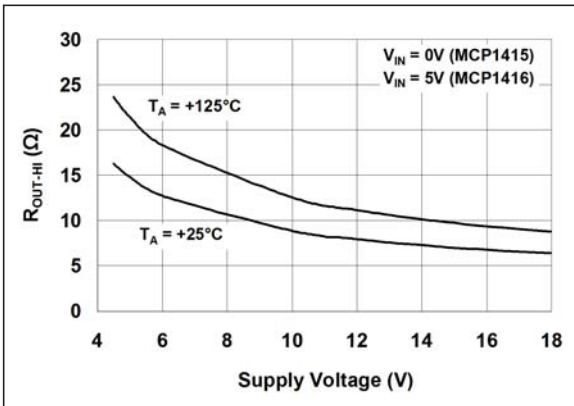
**FIGURE 2-15:** Supply Current vs. Capacitive Load.



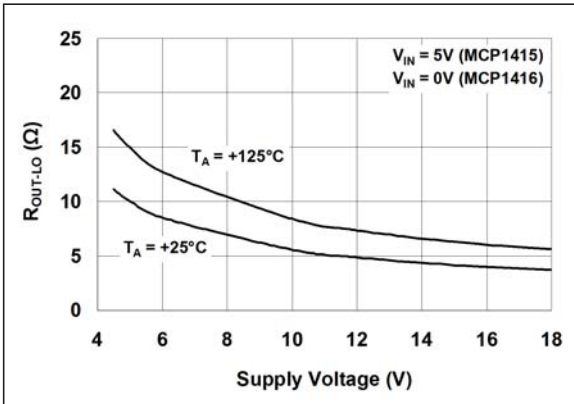
**FIGURE 2-18:** Supply Current vs. Frequency.

# MCP1415/16

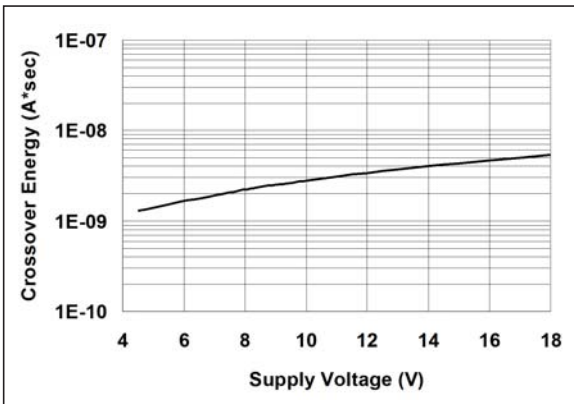
Note: Unless otherwise indicated,  $T_A = +25^\circ\text{C}$  with  $4.5\text{V} \leq V_{DD} \leq 18\text{V}$ .



**FIGURE 2-19:** Output Resistance (Output High) vs. Supply Voltage.



**FIGURE 2-20:** Output Resistance (Output Low) vs. Supply Voltage.



**FIGURE 2-21:** Crossover Energy vs. Supply Voltage.



## 3.0 PIN DESCRIPTIONS

The descriptions of the pins are listed in [Table 3-1](#).

**TABLE 3-1: PIN FUNCTION TABLE**

| Pin No.    |              | Symbol                             | Description   |
|------------|--------------|------------------------------------|---------------|
| MCP1415/16 | MCP1415R/16R |                                    |               |
| 1          | 1            | NC                                 | No Connection |
| 2          | 5            | $V_{DD}$                           | Supply Input  |
| 3          | 3            | IN                                 | Control Input |
| 4          | 2            | GND                                | Ground        |
| 5          | 4            | $\overline{\text{OUT}}/\text{OUT}$ | Output        |

### 3.1 Supply Input ( $V_{DD}$ )

$V_{DD}$  is the bias supply input for the MOSFET driver and has a voltage range of 4.5V to 18V. This input must be decoupled to ground with a local capacitor. This bypass capacitor provides a localized low-impedance path for the peak currents that are provided to the load.

### 3.2 Control Input (IN)

The MOSFET driver input is a high-impedance, TTL/CMOS compatible input. The input also has hysteresis between the high and low input levels, allowing them to be driven from slow rising and falling signals and to provide noise immunity.

### 3.3 Ground (GND)

Ground is the device return pin. The ground pin should have a low-impedance connection to the bias supply source return. When the capacitive load is being discharged, high peak currents will flow out of the ground pin.

### 3.4 Output (OUT, $\overline{\text{OUT}}$ )

The output is a CMOS push-pull output that is capable of sourcing and sinking 1.5A of peak current ( $V_{DD} = 18V$ ). The low output impedance ensures the gate of the external MOSFET stays in the intended state even during large transients. This output also has a reverse current latch-up rating of 500 mA.

# MCP1415/16

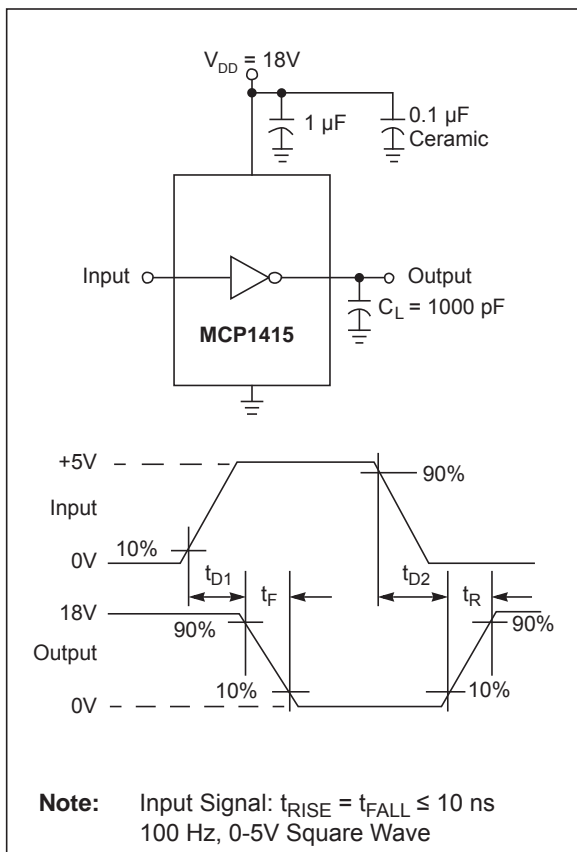
## 4.0 APPLICATION INFORMATION

### 4.1 General Information

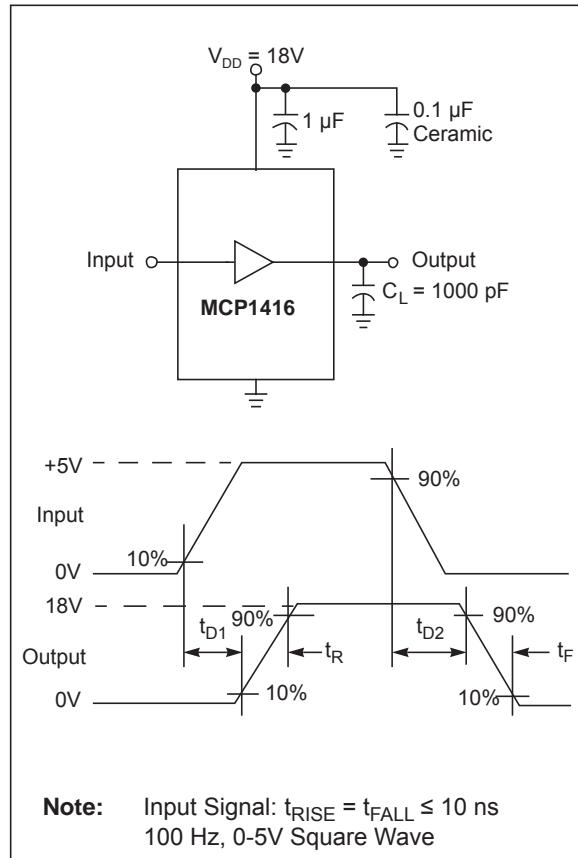
MOSFET drivers are high-speed, high-current devices which are intended to source/sink high peak currents to charge/discharge the gate capacitance of external MOSFETs or Insulated-Gate Bipolar Transistors (IGBTs). In high frequency switching power supplies, the Pulse-Width Modulation (PWM) controller may not have the drive capability to directly drive the power MOSFET. A MOSFET driver such as the MCP1415/16 family can be used to provide additional source/sink current capability.

### 4.2 MOSFET Driver Timing

The ability of a MOSFET driver to transition from a fully-off state to a fully-on state is characterized by the driver's rise time ( $t_R$ ), fall time ( $t_F$ ) and propagation delays ( $t_{D1}$  and  $t_{D2}$ ). Figure 4-1 and Figure 4-2 show the test circuit and timing waveform used to verify the MCP1415/16 timing.



**FIGURE 4-1:** Inverting Driver Timing Waveform.



**FIGURE 4-2:** Non-Inverting Driver Timing Waveform.

### 4.3 Decoupling Capacitors

Careful layout and decoupling capacitors are required when using power MOSFET drivers. Large current is required to charge and discharge capacitive loads quickly. For example, approximately 720 mA are needed to charge a 1000 pF load with 18V in 25 ns.

To operate the MOSFET driver over a wide frequency range with low supply impedance, it is recommended to place a ceramic and a low ESR film capacitor in parallel between the driver  $V_{DD}$  and GND. A 1.0  $\mu$ F low ESR film capacitor and a 0.1  $\mu$ F ceramic capacitor placed between pins 2 and 4 are required for reliable operation. These capacitors should be placed close to the driver to minimize circuit board parasitics and provide a local source for the required current.

## 4.4 Power Dissipation

The total internal power dissipation in a MOSFET driver is the summation of three separate power dissipation elements.

### EQUATION 4-1:

$$P_T = P_L + P_Q + P_{CC}$$

Where:

|          |   |                             |
|----------|---|-----------------------------|
| $P_T$    | = | Total power dissipation     |
| $P_L$    | = | Load power dissipation      |
| $P_Q$    | = | Quiescent power dissipation |
| $P_{CC}$ | = | Operating power dissipation |

### 4.4.1 CAPACITIVE LOAD DISSIPATION

The power dissipation caused by a capacitive load is a direct function of the frequency, total capacitive load and supply voltage. The power lost in the MOSFET driver for a complete charging and discharging cycle of a MOSFET is shown in Equation 4-2.

### EQUATION 4-2:

$$P_L = f \times C_T \times V_{DD}^2$$

Where:

|          |   |                              |
|----------|---|------------------------------|
| $f$      | = | Switching frequency          |
| $C_T$    | = | Total load capacitance       |
| $V_{DD}$ | = | MOSFET driver supply voltage |

### 4.4.2 QUIESCENT POWER DISSIPATION

The power dissipation associated with the quiescent current draw depends on the state of the input pin. The MCP1415/16 devices have a quiescent current draw of 0.65 mA (typical) when the input is high and of 0.1 mA (typical) when the input is low. The quiescent power dissipation is shown in Equation 4-3.

### EQUATION 4-3:

$$P_Q = (I_{QH} \times D + I_{QL} \times (1 - D)) \times V_{DD}$$

Where:

|          |   |                                     |
|----------|---|-------------------------------------|
| $I_{QH}$ | = | Quiescent current in the High state |
| $D$      | = | Duty cycle                          |
| $I_{QL}$ | = | Quiescent current in the Low state  |
| $V_{DD}$ | = | MOSFET driver supply voltage        |

### 4.4.3 OPERATING POWER DISSIPATION

The operating power dissipation occurs each time the MOSFET driver output transitions because, for a very short period of time, both MOSFETs in the output stage are on simultaneously. This cross-conduction current leads to a power dissipation described in Equation 4-4.

### EQUATION 4-4:

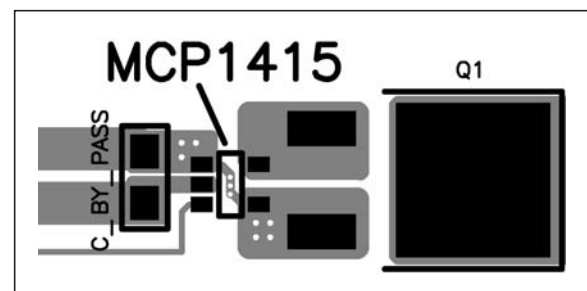
$$P_{CC} = CC \times f \times V_{DD}$$

Where:

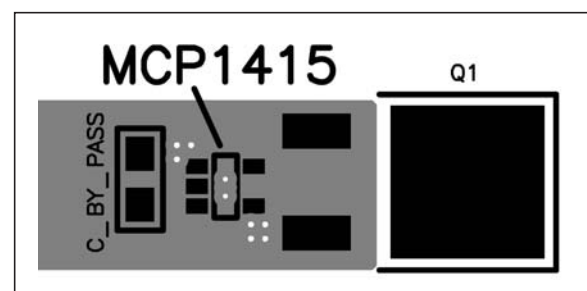
|          |   |                                   |
|----------|---|-----------------------------------|
| $CC$     | = | Cross-Conduction constant (A*sec) |
| $f$      | = | Switching frequency               |
| $V_{DD}$ | = | MOSFET driver supply voltage      |

## 4.5 PCB Layout Considerations

Proper PCB layout is important in high-current, fast switching circuits to provide proper device operation and robustness of design. Improper component placement may cause errant switching, excessive voltage ringing or circuit latch-up. PCB trace loop area and inductance must be minimized. This is accomplished by placing the MOSFET driver directly at the load and placing the bypass capacitor directly at the MOSFET driver (see Figure 4-3). Locating ground planes or ground return traces directly beneath the driver output signal reduces trace inductance. A ground plane also helps as a radiated noise shield and it provides some heat sinking for power dissipated within the device (see Figure 4-4).



**FIGURE 4-3:** Recommended PCB Layout (TOP).



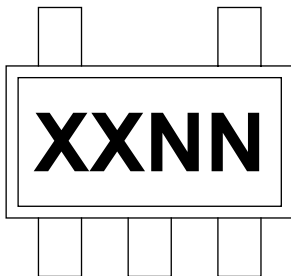
**FIGURE 4-4:** Recommended PCB Layout (BOTTOM).

# MCP1415/16

## 5.0 PACKAGING INFORMATION

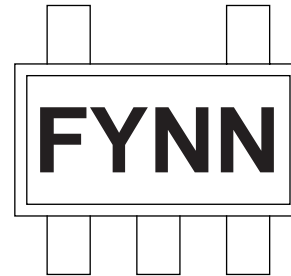
### 5.1 Package Marking Information

5-Lead SOT-23



| Standard Markings for SOT-23 |      |
|------------------------------|------|
| Part Number                  | Code |
| MCP1415T-E/OT                | FYNN |
| MCP1415RT-E/OT               | F7NN |
| MCP1416T-E/OT                | FZNN |
| MCP1416RT-E/OT               | F8NN |

Example

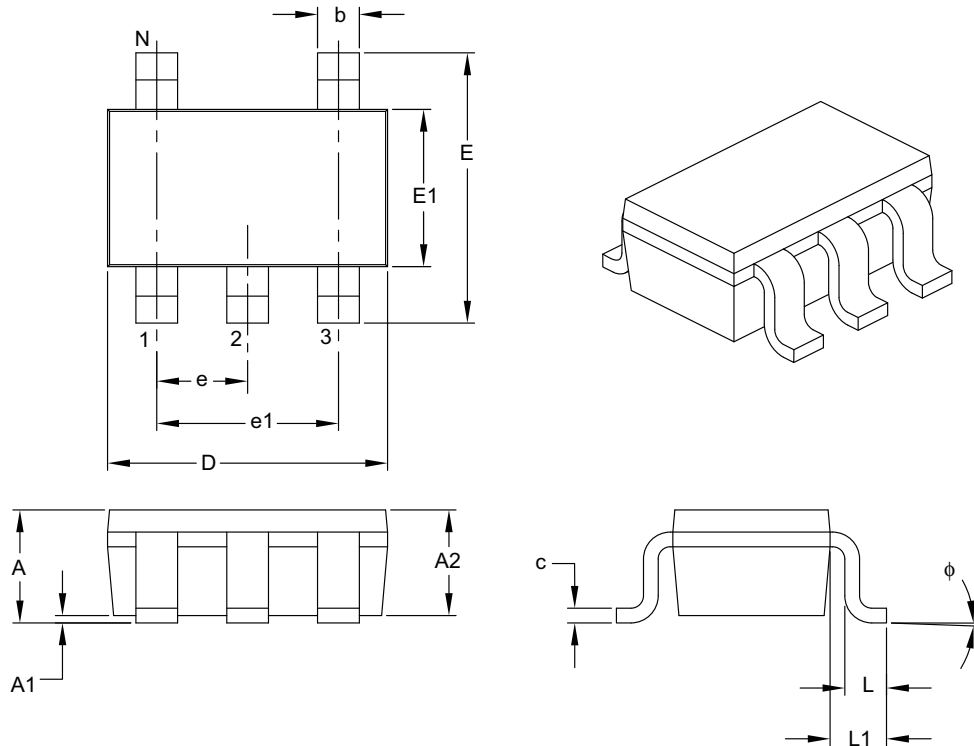


|                |        |  |
|----------------|--------|--|
| <b>Legend:</b> | XX...X | Customer-specific information  |
|                | Y      | Year code (last digit of calendar year)  |
|                | YY     | Year code (last 2 digits of calendar year)   |
|                | WW     | Week code (week of January 1 is week '01')   |
|                | NNN    | Alphanumeric traceability code   |
|                | (e3)   | Pb-free JEDEC <sup>®</sup> designator for Matte Tin (Sn)   |
|                | *      | This package is Pb-free. The Pb-free JEDEC designator (e3) can be found on the outer packaging for this package. |

**Note:** In the event the full Microchip part number cannot be marked on one line, it will be carried over to the next line, thus limiting the number of available characters for customer-specific information.

## 5-Lead Plastic Small Outline Transistor (OT) [SOT-23]

**Note:** For the most current package drawings, please see the Microchip Packaging Specification located at <http://www.microchip.com/packaging>



| Dimension Limits         | Units  | MILLIMETERS |     |      |
|--------------------------|--------|-------------|-----|------|
|                          |        | MIN         | NOM | MAX  |
| Number of Pins           | N      | 5           |     |      |
| Lead Pitch               | e      | 0.95 BSC    |     |      |
| Outside Lead Pitch       | e1     | 1.90 BSC    |     |      |
| Overall Height           | A      | 0.90        | –   | 1.45 |
| Molded Package Thickness | A2     | 0.89        | –   | 1.30 |
| Standoff                 | A1     | 0.00        | –   | 0.15 |
| Overall Width            | E      | 2.20        | –   | 3.20 |
| Molded Package Width     | E1     | 1.30        | –   | 1.80 |
| Overall Length           | D      | 2.70        | –   | 3.10 |
| Foot Length              | L      | 0.10        | –   | 0.60 |
| Footprint                | L1     | 0.35        | –   | 0.80 |
| Foot Angle               | $\phi$ | 0°          | –   | 30°  |
| Lead Thickness           | c      | 0.08        | –   | 0.26 |
| Lead Width               | b      | 0.20        | –   | 0.51 |

**Notes:**

- Dimensions D and E1 do not include mold flash or protrusions. Mold flash or protrusions shall not exceed 0.127 mm per side.
- Dimensioning and tolerancing per ASME Y14.5M.

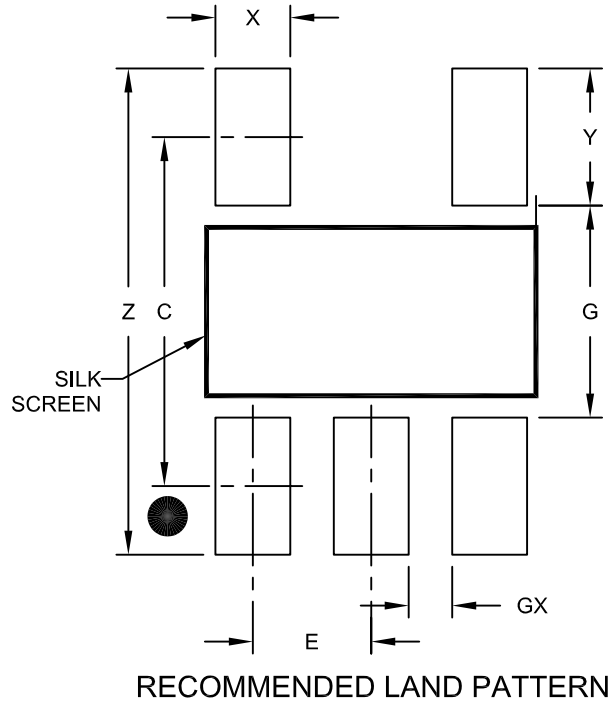
BSC: Basic Dimension. Theoretically exact value shown without tolerances.

Microchip Technology Drawing C04-091B

# MCP1415/16

## 5-Lead Plastic Small Outline Transistor (OT) [SOT-23]

**Note:** For the most current package drawings, please see the Microchip Packaging Specification located at <http://www.microchip.com/packaging>



| Dimension Limits        | Units | MILLIMETERS |      |      |
|-------------------------|-------|-------------|------|------|
|                         |       | MIN         | NOM  | MAX  |
| Contact Pitch           | E     | 0.95 BSC    |      |      |
| Contact Pad Spacing     | C     |             | 2.80 |      |
| Contact Pad Width (X5)  | X     |             |      | 0.60 |
| Contact Pad Length (X5) | Y     |             |      | 1.10 |
| Distance Between Pads   | G     | 1.70        |      |      |
| Distance Between Pads   | GX    | 0.35        |      |      |
| Overall Width           | Z     |             |      | 3.90 |

**Notes:**

1. Dimensioning and tolerancing per ASME Y14.5M

BSC: Basic Dimension. Theoretically exact value shown without tolerances.

Microchip Technology Drawing No. C04-2091A

## APPENDIX A: REVISION HISTORY

### Revision G (June 2016)

The following is the list of modifications:

1. Updated [Features](#).
2. Updated [Section “DC Characteristics”](#).
3. Updated [Section “DC Characteristics \(Over Operating Temperature Range\) \(Note 1\)”](#).
4. Updated [Figure 2-3](#), [Figure 2-6](#), [Figure 2-7](#) and [Figure 2-8](#).
5. Updated [Figure 4-1](#) and [Figure 4-2](#).
6. Minor typographical corrections.

### Revision F (July 2014)

The following is the list of modifications:

1. Fixed a typographical error for the electrostatic discharge (ESD) value in [Absolute Maximum Ratings †](#).
2. Minor grammatical and editorial corrections.

### Revision E (May 2012)

The following is the list of modifications:

1. Updated the Electrostatic Discharge (ESD) value.

### Revision D (December 2010)

The following is the list of modifications:

1. Updated [Figure 2-19](#) and [Figure 2-20](#).
2. Updated the package outline drawings.

### Revision C (December 2008)

The following is the list of modifications:

Added the MCP1415R/16R devices throughout the document.

### Revision B (June 2008)

The following is the list of modifications:

1. [Section “DC Characteristics”](#), Switching Time, Rise Time: changed from 13 to 20.
2. [Section “DC Characteristics”](#), Switching Time, Fall Time: changed from 13 to 20.
3. [Section “DC Characteristics \(Over Operating Temperature Range\) \(Note 1\)”](#) (Over Operating Temperature Range), Switching Time, Rise Time: changed maximum from 35 to 40.
4. [Section “DC Characteristics \(Over Operating Temperature Range\) \(Note 1\)”](#) (Over Operating Temperature Range), Switching Time, Rise Time: changed typical from 25 to 30.
5. [Section “DC Characteristics \(Over Operating Temperature Range\) \(Note 1\)”](#) (Over Operating Temperature Range), Switching Time, Fall Time: changed maximum from 35 to 40.
6. [Section “DC Characteristics \(Over Operating Temperature Range\) \(Note 1\)”](#) (Over Operating Temperature Range), Switching Time, Fall Time: changed typical from 25 to 30.

### Revision A (June 2008)

Original release of this document.

---

**Note the following details of the code protection feature on Microchip devices:**

- Microchip products meet the specification contained in their particular Microchip Data Sheet.
- Microchip believes that its family of products is one of the most secure families of its kind on the market today, when used in the intended manner and under normal conditions.
- There are dishonest and possibly illegal methods used to breach the code protection feature. All of these methods, to our knowledge, require using the Microchip products in a manner outside the operating specifications contained in Microchip's Data Sheets. Most likely, the person doing so is engaged in theft of intellectual property.
- Microchip is willing to work with the customer who is concerned about the integrity of their code.
- Neither Microchip nor any other semiconductor manufacturer can guarantee the security of their code. Code protection does not mean that we are guaranteeing the product as “unbreakable.”

Code protection is constantly evolving. We at Microchip are committed to continuously improving the code protection features of our products. Attempts to break Microchip's code protection feature may be a violation of the Digital Millennium Copyright Act. If such acts allow unauthorized access to your software or other copyrighted work, you may have a right to sue for relief under that Act.

---

Information contained in this publication regarding device applications and the like is provided only for your convenience and may be superseded by updates. It is your responsibility to ensure that your application meets with your specifications. MICROCHIP MAKES NO REPRESENTATIONS OR WARRANTIES OF ANY KIND WHETHER EXPRESS OR IMPLIED, WRITTEN OR ORAL, STATUTORY OR OTHERWISE, RELATED TO THE INFORMATION, INCLUDING BUT NOT LIMITED TO ITS CONDITION, QUALITY, PERFORMANCE, MERCHANTABILITY OR FITNESS FOR PURPOSE. Microchip disclaims all liability arising from this information and its use. Use of Microchip devices in life support and/or safety applications is entirely at the buyer's risk, and the buyer agrees to defend, indemnify and hold harmless Microchip from any and all damages, claims, suits, or expenses resulting from such use. No licenses are conveyed, implicitly or otherwise, under any Microchip intellectual property rights unless otherwise stated.

*Microchip received ISO/TS-16949:2009 certification for its worldwide headquarters, design and wafer fabrication facilities in Chandler and Tempe, Arizona; Gresham, Oregon and design centers in California and India. The Company's quality system processes and procedures are for its PIC® MCUs and dsPIC® DSCs, KEELoq® code hopping devices, Serial EEPROMs, microperipherals, nonvolatile memory and analog products. In addition, Microchip's quality system for the design and manufacture of development systems is ISO 9001:2000 certified.*

**QUALITY MANAGEMENT SYSTEM  
CERTIFIED BY DNV  
= ISO/TS 16949 =**

### Trademarks

The Microchip name and logo, the Microchip logo, AnyRate, dsPIC, FlashFlex, flexPWR, Heldo, JukeBlox, KeeLoq, KeeLoq logo, Klear, LANCheck, LINK MD, MediaLB, MOST, MOST logo, MPLAB, OptoLyzer, PIC, PICSTART, PIC32 logo, RightTouch, SpyNIC, SST, SST Logo, SuperFlash and UNI/O are registered trademarks of Microchip Technology Incorporated in the U.S.A. and other countries.

ClockWorks, The Embedded Control Solutions Company, ETHERSYNCH, Hyper Speed Control, HyperLight Load, IntelliMOS, mTouch, Precision Edge, and QUIET-WIRE are registered trademarks of Microchip Technology Incorporated in the U.S.A.

Analog-for-the-Digital Age, Any Capacitor, AnyIn, AnyOut, BodyCom, chipKIT, chipKIT logo, CodeGuard, dsPICDEM, dsPICDEM.net, Dynamic Average Matching, DAM, ECAN, EtherGREEN, In-Circuit Serial Programming, ICSP, Inter-Chip Connectivity, JitterBlocker, KlearNet, KlearNet logo, MiWi, motorBench, MPASM, MPF, MPLAB Certified logo, MPLIB, MPLINK, MultiTRAK, NetDetach, Omniscient Code Generation, PICDEM, PICDEM.net, PICkit, PICtail, PureSilicon, RightTouch logo, REAL ICE, Ripple Blocker, Serial Quad I/O, SQL, SuperSwitcher, SuperSwitcher II, Total Endurance, TSHARC, USBCheck, VariSense, ViewSpan, WiperLock, Wireless DNA, and ZENA are trademarks of Microchip Technology Incorporated in the U.S.A. and other countries.

SQTP is a service mark of Microchip Technology Incorporated in the U.S.A.

Silicon Storage Technology is a registered trademark of Microchip Technology Inc. in other countries.

GestIC is a registered trademarks of Microchip Technology Germany II GmbH & Co. KG, a subsidiary of Microchip Technology Inc., in other countries.

All other trademarks mentioned herein are property of their respective companies.

© 2008-2016, Microchip Technology Incorporated, Printed in the U.S.A., All Rights Reserved.

ISBN:





# MICROCHIP

## Worldwide Sales and Service

### AMERICAS

**Corporate Office**  
2355 West Chandler Blvd.  
Chandler, AZ 85224-6199  
Tel: 480-792-7200  
Fax: 480-792-7277  
Technical Support:  
<http://www.microchip.com/support>  
Web Address:  
[www.microchip.com](http://www.microchip.com)

**Atlanta**  
Duluth, GA  
Tel: 678-957-9614  
Fax: 678-957-1455

**Austin, TX**  
Tel: 512-257-3370

**Boston**  
Westborough, MA  
Tel: 774-760-0087  
Fax: 774-760-0088

**Chicago**  
Itasca, IL  
Tel: 630-285-0071  
Fax: 630-285-0075

**Cleveland**  
Independence, OH  
Tel: 216-447-0464  
Fax: 216-447-0643

**Dallas**  
Addison, TX  
Tel: 972-818-7423  
Fax: 972-818-2924

**Detroit**  
Novi, MI  
Tel: 248-848-4000

**Houston, TX**  
Tel: 281-894-5983

**Indianapolis**  
Noblesville, IN  
Tel: 317-773-8323  
Fax: 317-773-5453

**Los Angeles**  
Mission Viejo, CA  
Tel: 949-462-9523  
Fax: 949-462-9608

**New York, NY**  
Tel: 631-435-6000

**San Jose, CA**  
Tel: 408-735-9110

**Canada - Toronto**  
Tel: 905-673-0699  
Fax: 905-673-6509

### ASIA/PACIFIC

**Asia Pacific Office**  
Suites 3707-14, 37th Floor  
Tower 6, The Gateway  
Harbour City, Kowloon

**Hong Kong**  
Tel: 852-2943-5100  
Fax: 852-2401-3431

**Australia - Sydney**  
Tel: 61-2-9868-6733  
Fax: 61-2-9868-6755

**China - Beijing**  
Tel: 86-10-8569-7000  
Fax: 86-10-8528-2104

**China - Chengdu**  
Tel: 86-28-8665-5511  
Fax: 86-28-8665-7889

**China - Chongqing**  
Tel: 86-23-8980-9588  
Fax: 86-23-8980-9500

**China - Dongguan**  
Tel: 86-769-8702-9880

**China - Hangzhou**  
Tel: 86-571-8792-8115  
Fax: 86-571-8792-8116

**China - Hong Kong SAR**  
Tel: 852-2943-5100  
Fax: 852-2401-3431

**China - Nanjing**  
Tel: 86-25-8473-2460  
Fax: 86-25-8473-2470

**China - Qingdao**  
Tel: 86-532-8502-7355  
Fax: 86-532-8502-7205

**China - Shanghai**  
Tel: 86-21-5407-5533  
Fax: 86-21-5407-5066

**China - Shenyang**  
Tel: 86-24-2334-2829  
Fax: 86-24-2334-2393

**China - Shenzhen**  
Tel: 86-755-8864-2200  
Fax: 86-755-8203-1760

**China - Wuhan**  
Tel: 86-27-5980-5300  
Fax: 86-27-5980-5118

**China - Xian**  
Tel: 86-29-8833-7252  
Fax: 86-29-8833-7256

### ASIA/PACIFIC

**China - Xiamen**  
Tel: 86-592-2388138  
Fax: 86-592-2388130

**China - Zhuhai**  
Tel: 86-756-3210040  
Fax: 86-756-3210049

**India - Bangalore**  
Tel: 91-80-3090-4444  
Fax: 91-80-3090-4123

**India - New Delhi**  
Tel: 91-11-4160-8631  
Fax: 91-11-4160-8632

**India - Pune**  
Tel: 91-20-3019-1500

**Japan - Osaka**  
Tel: 81-6-6152-7160  
Fax: 81-6-6152-9310

**Japan - Tokyo**  
Tel: 81-3-6880-3770  
Fax: 81-3-6880-3771

**Korea - Daegu**  
Tel: 82-53-744-4301  
Fax: 82-53-744-4302

**Korea - Seoul**  
Tel: 82-2-554-7200  
Fax: 82-2-558-5932 or  
82-2-558-5934

**Malaysia - Kuala Lumpur**  
Tel: 60-3-6201-9857  
Fax: 60-3-6201-9859

**Malaysia - Penang**  
Tel: 60-4-227-8870  
Fax: 60-4-227-4068

**Philippines - Manila**  
Tel: 63-2-634-9065  
Fax: 63-2-634-9069

**Singapore**  
Tel: 65-6334-8870  
Fax: 65-6334-8850

**Taiwan - Hsin Chu**  
Tel: 886-3-5778-366  
Fax: 886-3-5770-955

**Taiwan - Kaohsiung**  
Tel: 886-7-213-7828

**Taiwan - Taipei**  
Tel: 886-2-2508-8600  
Fax: 886-2-2508-0102

**Thailand - Bangkok**  
Tel: 66-2-694-1351  
Fax: 66-2-694-1350

### EUROPE

**Austria - Wels**  
Tel: 43-7242-2244-39  
Fax: 43-7242-2244-393

**Denmark - Copenhagen**  
Tel: 45-4450-2828  
Fax: 45-4485-2829

**France - Paris**  
Tel: 33-1-69-53-63-20  
Fax: 33-1-69-30-90-79

**Germany - Dusseldorf**  
Tel: 49-2129-3766400

**Germany - Karlsruhe**  
Tel: 49-721-625370

**Germany - Munich**  
Tel: 49-89-627-144-0  
Fax: 49-89-627-144-44

**Italy - Milan**  
Tel: 39-0331-742611  
Fax: 39-0331-466781

**Italy - Venice**  
Tel: 39-049-7625286

**Netherlands - Drunen**  
Tel: 31-416-690399  
Fax: 31-416-690340

**Poland - Warsaw**  
Tel: 48-22-3325737

**Spain - Madrid**  
Tel: 34-91-708-08-90  
Fax: 34-91-708-08-91

**Sweden - Stockholm**  
Tel: 46-8-5090-4654

**UK - Wokingham**  
Tel: 44-118-921-5800  
Fax: 44-118-921-5820

07/14/15

# Mouser Electronics

Authorized Distributor

Click to View Pricing, Inventory, Delivery & Lifecycle Information:

[Microchip:](#)

[MCP1415T-E/OT](#) [MCP1416T-E/OT](#) [MCP1416RT-E/OT](#)